

After Power ON, the Status LED on a Clevertest Plus enabled fitting will display a rapid Green or Red flashing for a period up to 2 minutes.

Zoneworks HIVE Monitored Options

Fittings with part numbers -HVG are fitted with Zoneworks HIVE communications modules (nodes). These fittings are monitored using RF transceiver modules operating in the ISM band connected to a central Server (can also be connected via Ethernet/Internet/Fibre). Zoneworks software on the server is used to monitor, coordinate testing and collate test data from each fitting. Zoneworks HIVE Fittings can be commissioned by scanning the supplied barcode. The LED indicator provides a multifunction indication of the status of the fitting during testing and normal operation:

Option	State	LED Operation
HVG	Commissioned	LED on Solid (Green)
HVG	Un-commissioned With network connectivity	Batt plugged-in: yellow 1s, green 1s
		Batt unplugged: red 1s, off 1s
HVG	Un-commissioned Without network connectivity	Batt plugged-in: yellow 250mS, green 250mS, yellow 250mS, green 250mS, green 1s
		Batt unplugged: red 250mS, off 250mS, red 250mS, off 250mS, off 1s
HVG	Emergency Light Test In Progress	LED flashes at yellow 1s , Off 1s

For further information of installation of a Zoneworks system, please refer to the Zoneworks Users Guide and Commissioning Guide.

DALI EM Option

Luminaires with part numbers having -DALI are fitted with DALI modules (nodes) that facilitate connection and integration to 3rd Party Lighting Control Systems. Before installing the -DALI fitting please confirm that the Lighting Control System has the capability to monitor DALI Emergency Luminaires. The -DALI fitting will be addressed and configured into the control system by the Lighting Control System Commissioning Technicians and not Clevertronics

State	LED Operation
Commissioned/ Un-commissioned	LED on Solid (Green)
Emergency Light Test in progress	LED flashes at 1s On (Yellow) & 1s Off
“IDENTIFY COMMAND”	Lamp and Status LED Flash for 30 seconds

A 2-way “figure 8” cable and terminal block facilitates the connection to the DALI network OR a 5/6way “structured wiring system” lead and plug facilitating the power and DALI connection. DALI connections are marked as Da Da.

Note:

This luminaire (with reinforced insulation between control/LED terminal and AC supply) contains non-user replaceable light source and battery - to be replaced (if required, refer installation instructions for battery replacement) by Clevertronics service personnel/agents or a registered electrician.

If flexible wiring is connected to this luminaire and is within arm’s reach, the wiring shall be effectively fixed to the wall to reduce the risk of strangulation.

Warranty:

For Product Warranty information and Terms and Conditions of Sales please refer to our website <https://clevertronics.co.uk/product-warranty-statement/>



**FORM 20m Exit
Installation & Maintenance Instruction Leaflet**



NOTE: Standard product codes with this symbol  are enabled with Clevertest Plus capability. Please refer to the operation guide supplied with the product for details.



Australia (Head Office)
Website: www.clevertronics.com.au
Email: info@clevertronics.com.au
Phone: +61 3 9559 2700
Fax: +61 3 9559 2799

UK OFFICE
Website: www.clevertronics.co.uk
362 Stockley Close
West Drayton UB7 9BL
Phone: 01895 430 255

Models:

FORM-20-SM-WM-L10-xx-yy

Testing:

Manual Test xx = Blank
Zoneworks HIVE xx = HVG
DALI Registered. xx = DALI



Options:

No EM Lens yy = Blank
EM Lens yy = ESC

Spare Parts:

1530050 Replacement Battery
UKM01370320001 Replacement Emergency Driver

Important:

It is illegal for anyone, except for a licensed electrician to install or maintain this product. Before installation, ensure that the electricity supply has been switched off and isolated. Installation must be carried out in accordance with the relevant British Standards.

Caution

On many building sites, power circuits may be cut off in an uncontrolled and repetitive basis during construction. As a result, any Exit & Emergency Units, on these circuits, will have their batteries discharged or “cycled”. The Li-ion battery in the Exit & Emergency Unit has been selected to give excellent long life performance in a controlled IEC 60598-2-22 testing environment. Excessive battery cycling will reduce through-life performance and may lead to premature battery failure. Battery warranty claims, as a result of such abuse, are specifically EXCLUDED from Clevertronics warranty terms.

Dimensions:

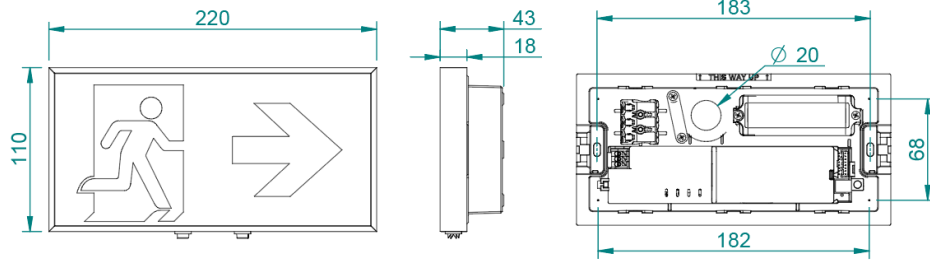

Installation:

Please follow the below steps to install the product correctly:

BOX INSTALLATION

- Insert cable through the appropriate cable entry and leave enough cable to reach into the terminal block
- Mark and install box using Mounting Slots (A) or Additional Mounting Points (B) inside box. If using option B, provisions must be done to ensure mounting points are sealed (see Figure 1)
- Wire mains power cable, 240V 50Hz, to terminals marked L, N & E (and DALI Cable to terminals marked Da Da as applicable)
- Secure cables using Cable Clamp provided

BLADE INSTALLATION

- Connect Blade Loom into EM Driver (8way connector)
- Attach blade by pressing the Blade clips onto the catches of the box (see Figure 2). Ensure all clips are engaged correctly.
- Ensure correct decal is installed into product, if not, slide out default decal and replace with correct version (see Figure 3)
- Attach side extrusion to lock both blade and decal into place
- If the CTP capabilities are activated, please affix the CTP status label to a visible surface and Four Segment Marking on the product will include an "F" in third segment block.

Battery Replacement:

1. Prior to any work, isolate the power to the luminaire that requires battery replacement
2. Remove Side extrusion (see Figure 4)
3. Using a flat screwdriver, insert screwdriver (see Figure 5) and rotate away from the wall to disengage clip
4. Disconnect Blade from the EM Driver to gain full access into recessed box
5. Disconnect Battery from EM Driver and remove Battery Bracket & Battery
6. Replace Battery/Battery Bracket and connect to Emergency Driver.
7. Reinstall the blade connector and blade
8. Replace the side extrusion

Testing Procedure:

When the unit is connected to the un-switched active, it must be allowed to charge the battery for at least 24 hours. The Exit Lamps illuminate in normal conditions as well as during power fail. The Escape Lamps (for -ESC products only) only illuminate during a power fail. Conduct the following tests:

- The Exit Lamps & Escape Lamps must illuminate for at least 180 min after disconnection from the mains. If the unit fails to illuminate for the requisite time, remedial action must be taken to repair the situation and once completed, the unit must pass a subsequent test.
- Press and hold Test Button or switch Off Mains Supply, check that the Exit Lamps & Escape Lamps is **ON**.
- Release the Test Button or switch On Mains Supply, check that the Exit Lamps are **ON** & Escape Lamps are **OFF** (Non-maintained operation).

Installation/Maintenance Images:

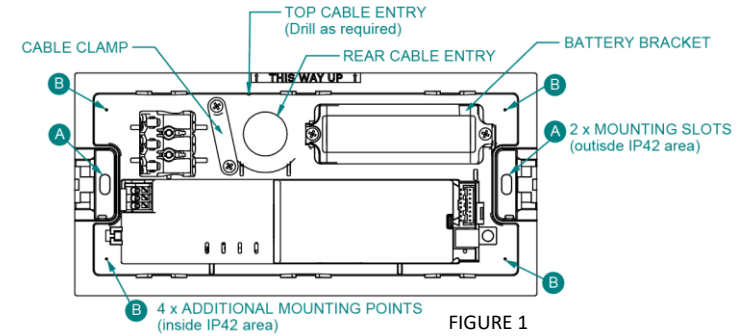

FIGURE 1

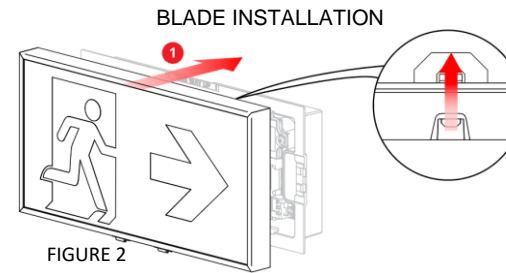

FIGURE 2

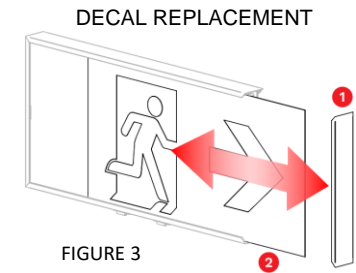

FIGURE 3

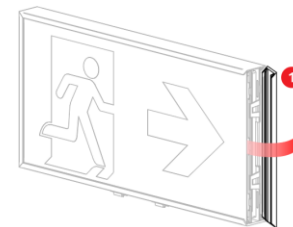

FIGURE 4

BLADE REMOVAL

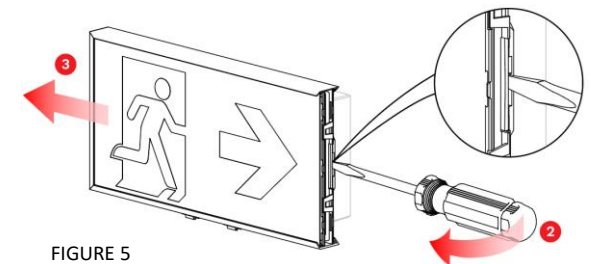

FIGURE 5

Trouble Shooting:

Below are a list of common problems and their possible causes.

Fault: The Green LED Test Switch indicator is not illuminated.

Check: A.C. is connected and is turned on.
Battery is connected
Test Switch for damage.
Blade loom is connected to Driver correctly

Fault: Lamp(s) does not illuminate in emergency mode.

Check: A.C. is connected.
Lamp is correctly inserted.
Battery is connected

Fault: Lamp(s) illuminates in emergency mode, but only stays on for a short period.

Check: Battery has been allowed to charge for at least 24 hours.
Battery for damage.